

ITEM

QTY

DESCRIPTION

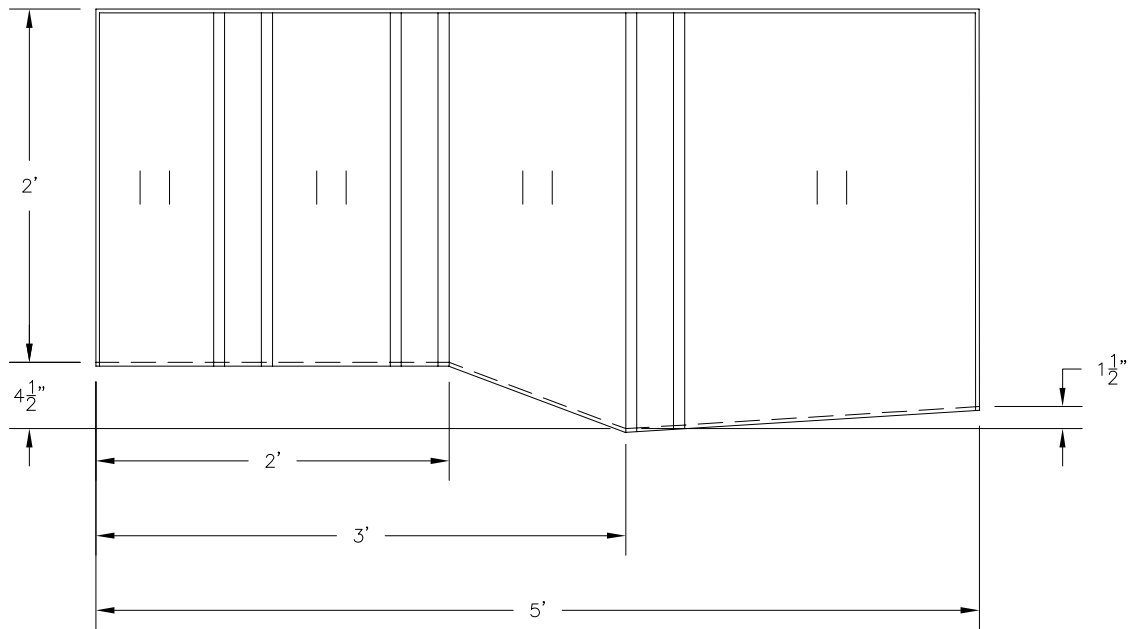
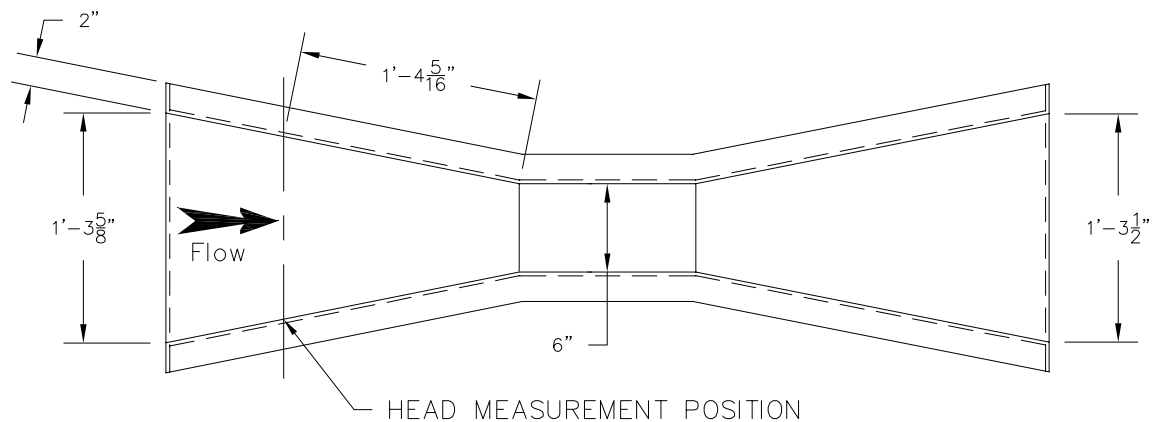

IMPORTANT NOTICE
 VIRTUAL POLYMER COMPOUNDS, LLC
 WILL NOT PROCEED WITH FABRICATION UNTIL A
 SIGNED APPROVAL OF THIS DRAWING IS
 RECEIVED APPROVAL OR APPROVED AS NOTED
 (CIRCLE ONE)
 BY: _____ DATE: _____

-	ORIGINAL RELEASE	JFF	1/17/13
Rev.	DESCRIPTION	By	Date

VPC VIRTUAL POLYMER COMPOUNDS, LLC
 10478 RIDGE ROAD, MEDINA, NEW YORK 14103
 TOLL FREE: 888-290-9522 PHONE: 585-735-9668 FAX: 585-735-9965

TITLE: 6" PARSHALL FLUME

PROJECT:

SCALE: NONE	DATE: 1/17/13	PROJECT NO.:
-------------	---------------	--------------